

THE *Clifton* RANGE

**Stirred Baths
NE4-T Series
NE4-E Series**

This series of water baths features a low liquid level float switch and if the liquid drops below the recommended level heating is automatically switched OFF.

- top up liquid level, then switch off and back on again using the mains switch located on the rear of the thermostirrer.

IMPORTANT: ALWAYS FILL the water bath before connecting to the power supply.

Contents

About this Manual	3
General Notes	3
Symbols	3
Location	4
Unpacking	4
Safety	4
Assembly	4
Power Supply Lead and Connection to Electrical Supply	4
Liquid Level	5
Suitable Liquids	5
Front, Tank and Rear Views	6
Operating Instructions	7
Control Panel	7
General Use	7
Low Liquid Float Switch	7
General Cleaning	8
Cleaning external painted surfaces with Anti-bacterial finish	8
Cleaning the stainless steel tank	8
Descaling the stainless steel tank	9
Decontamination of Equipment	9
Virucidal Disinfectant	9
Disinfectant/Sterilant	9
3 Year Warranty	10
Out of Warranty	10
End of Life	10
Portable Appliance Testing	10
Accessories	11
Fitting Accessories	12
Spares/Service Diagram	13
Specification	14
Declaration of Conformity	15
Final Inspection and Electrical Safety Test Report	Enclosed Rear

About this Manual

This user Manual contains instructions which must be followed in order that the product is operated correctly.

General Notes

Please observe the following safety precautions:

1. Fill the tank prior to connection to power supply.
2. Connect only to a power supply with the corresponding voltage to that specified on the rating label positioned on the rear of the unit.
3. Ensure the power supply has a safety earth (ground) terminal.
4. Ensure the mains switch and power supply connector are accessible during use.
5. The mains supply cord fitted to this products is a heat resistant type and should be replaced by an equivalent type.
6. Do not block ventilation slots during use.
7. Always follow good laboratory practice by ensuring substances being heated present no risk of a hazard (explosion, implosion or release of toxic or flammable gases) or that these have been addressed. When heating substances where liberation of gases occurs suitable extraction should be used.
8. Use only liquids specified in this Instruction Manual within their specified temperature range.
9. Use caution when topping up or draining the tank as the liquid in the tank may be very hot or cold.
10. Drain before moving the bath. Allow the liquid to cool to 50° C or heat up to 10° C or above before draining.
11. Use caution when refilling as a hot heating element can create scalding steam.
12. Always use a lid or layer of polypropylene spheres when operating at temperatures above 60° C. Take care when lifting the lid. Steam and hot vapours can cause scalding.
13. Always use the display or a thermometer to check the temperature - do not touch liquid.
14. If this product is not used in accordance with these instructions, then basic safety protection afforded by the water bath may be affected.
15. Check the operation of the low liquid level float switch regularly.
16. Before using any cleaning or decontamination method except those recommended, check with your distributor that the proposed method will not damage the equipment.

Amendments

Issue 1	February	2004	New book dedicated to NE4T's.
Issue 2	December	2004	Amendment to Service Diagram.
Issue 3	December	2005	Updated to service diagram.
Issue 4	August	2006	Update for WEE, DOC, accessories, overview, cleaning
Issue 5	November	2006	Anti-bacterial paint finish
Issue 6	May	2013	Updated with E version instructions.

Symbols



HOT SURFACES

Paragraphs marked by this symbol indicate that a potential hazard to your personal safety exists from heated surfaces or other appendages on the outside or inside of the equipment.



CAUTION

This icon accompanies text and/or other international symbols dealing with potential damage to equipment. When present, it indicates that there is a potential danger of equipment damage may occur if information stated within the "CAUTION" paragraph is not adhered to or procedures are executed incorrectly.



PROTECTIVE EARTH OR GROUND TERMINAL

Protective earth conductor terminal.

Location

The product must be placed on a smooth, level and sturdy work surface, preferably near a sink or drain for emptying. Use in a ventilated room. Suitable for use in ambient temperatures 5°C to 40°C with a maximum humidity 80% (temperature 31°C) decreasing to 50% (temperature 40°C).

Unpacking

Remove the product from its packaging. Any damage please notify your dealer immediately. Retain the packaging over the warranty period. Contents consist of a thermostirrer mounted on a stainless steel bridge unit to fit the selected tank, tank, stainless steel shelf, black nylon propellor, fasteners for securing the thermostirrer to the tank, power lead and an instruction manual.

Assembly NE4-T series

Turn the thermostirrer upside down and screw the nylon propellor hand tight onto the spindle. The spindle is threaded in the opposite direction to the propellor to ensure the propellor stays secure in use. Place the stainless steel shelf into the tank. Fit the thermostirrer onto the tank aligning the slots in the bridge unit with the holes in the side of the tank. Secure the thermostirrer to the tank using the the M4 screws and washers supplied.

Assembly NE4-E series

Turn the thermostirrer upside down and screw the nylon propellor hand tight onto the spindle. The spindle is threaded in the opposite direction to the propellor to ensure the propellor stays secure in use. Place the stainless steel shelf into the tank. Place digital thermostirrer mounted on stainless steel bridge onto right hand end of the clear tank. Place clamping plate inbetween the tank rim and stainless steel bridge - marked as "A" below. Fit screws into the bridge and clamping plate and tighten to secure the thermostirrer to the tank.

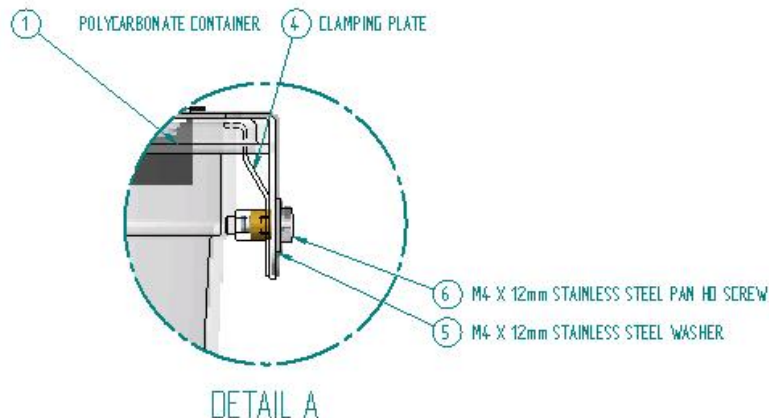

Safety



**Do not touch any electrical contacts or open any closure panels.
RISK OF ELECTRICAL SHOCK!**

**NE4-T series is Class 1 (IEC519 - Part 2) = low liquid level protection,
reference to over temperature condition providing product over
temperature protection.**

Power Supply Lead and Connection to Electrical Supply

Fit the power lead by plugging it into rear of the Thermostirrer and then to mains supply.



**Before connecting the product to the electrical supply, check the
information on the rating label is compatible.
IF IN DOUBT CONSULT AN ELECTRICIAN. THE PRODUCT MUST BE EARTHED!**

**Where the mains supply or plug connection differs refer to local
regulations or qualified electrician.**

Liquid Level

8, 14, 22 Litre Baths

Minimum liquid level - must cover the top of the false base by 70mm
Maximum liquid level - must not exceed the ridge in the tank.

28 Litre Baths

Minimum liquid level - must cover the top of the false base by 130mm.
Maximum liquid level - must not exceed the ridge in the tank.



When filling or emptying the bath disconnect the unit from the mains electrical supply.

Suitable Liquids

Operating temperatures and recommended liquid options:

Ambient to 99°C

Distilled water.

Heat transfer liquid. The LB range is formulated for temperatures from -45°C to 90°C and provides complete protection from algae growth and safeguards against corrosion. See accessories for the full range available.



Above 60°C or below room temperature it is recommended that to achieve optimum performance the bath should be covered with SL4 lid or polypropylene spheres.

NE4-T and NE4-E Series Stirred Thermostatic Baths

Front View

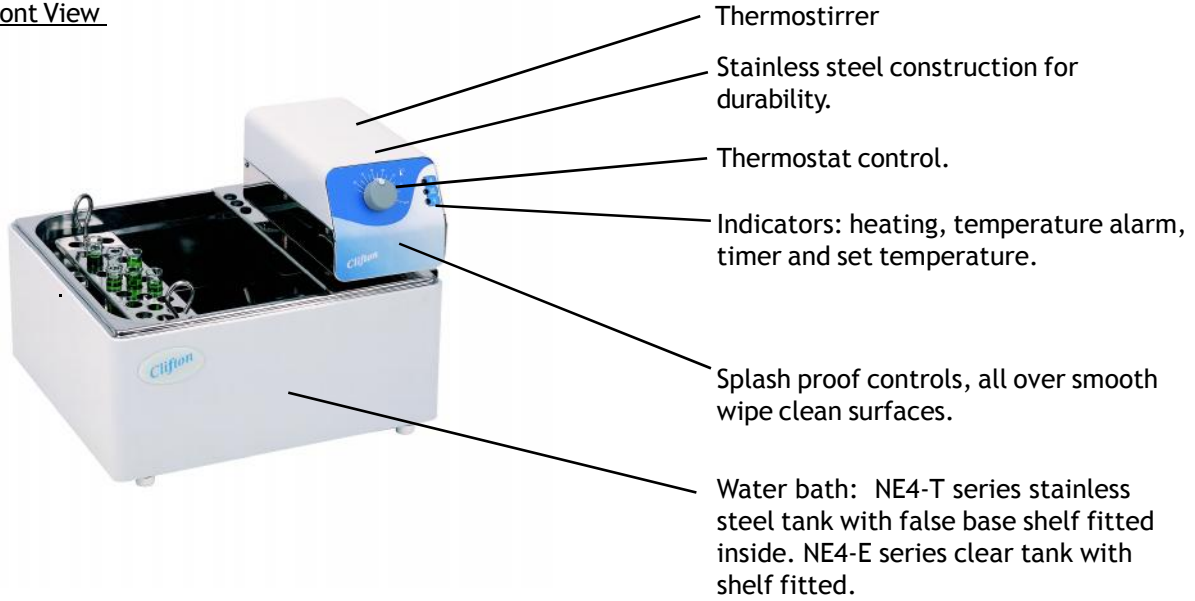

Tank View

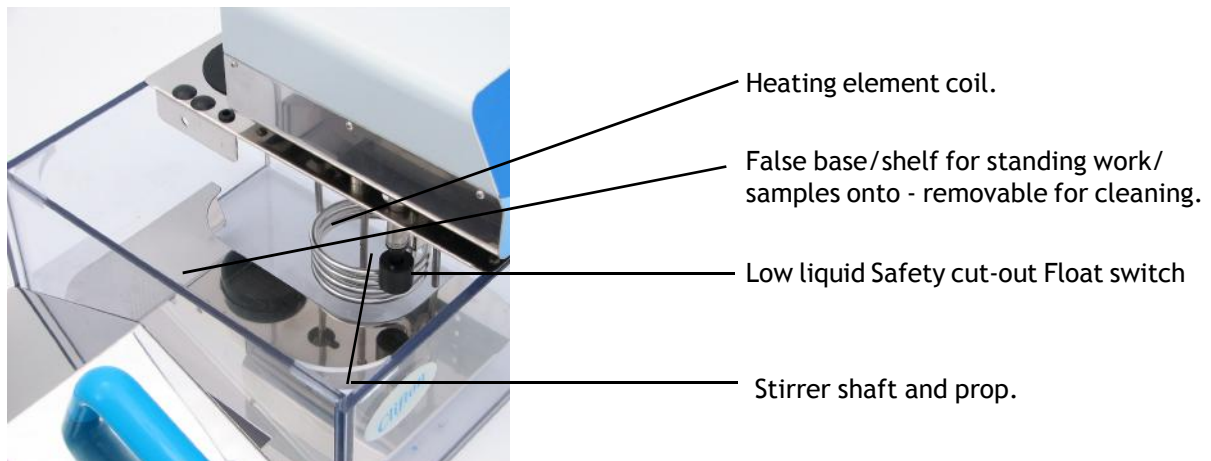

Rear View

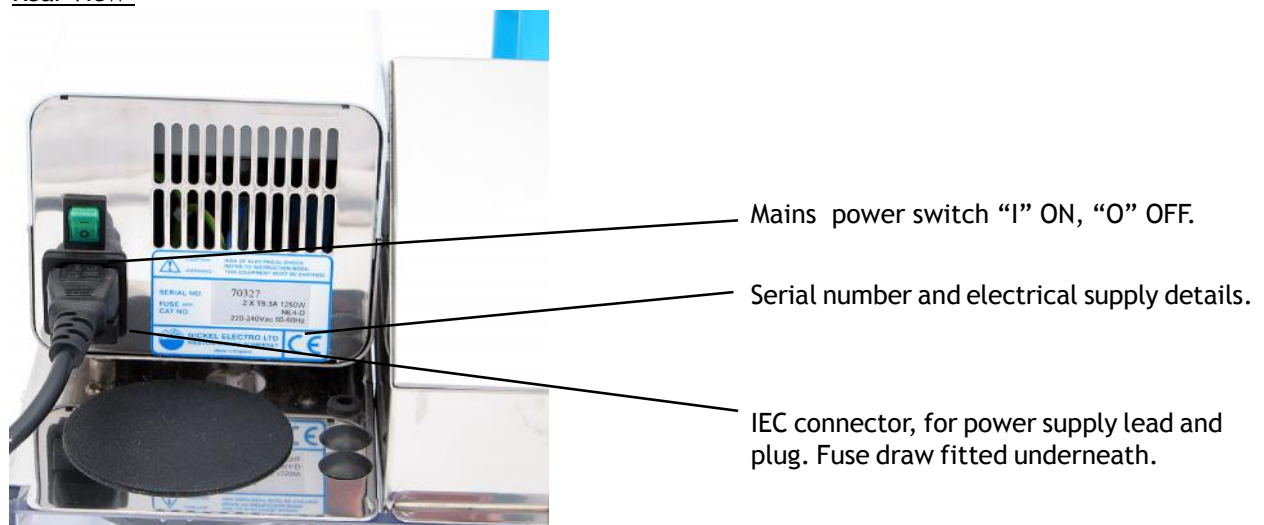

Operating Instructions

Control Panel

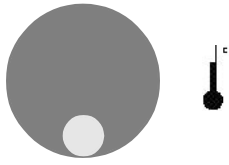

Temperature Dial



Low Liquid Level Alarm Indicator

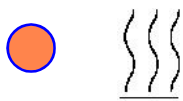

Heater Indicator

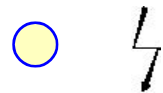

Power Indicator

General Use

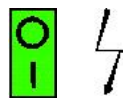

1. Ensure the bath has the required liquid level, then switch the unit ON "I" using the mains switch at the rear of the unit.

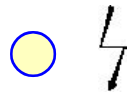

Power indicator will illuminate.



2. Adjust the temperature control to the desired setting. Allow the water temperature to stabilise and take an actual reading at the far end of the bath to the Thermostirrer. Where necessary adjust the temperature controller.

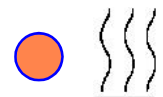

Heater indicator will illuminate.

Low Liquid Level Float Switch



The unit features a low liquid level float switch. This ensures heating will be switched off if the liquid level falls below the recommended level. The motor and heater are switched off in this instance. Use caution when refilling the tank as hot elements can spit and create scalding steam.

Cleaning

General



Important - please follow these instructions to avoid possible damage to the unit, otherwise affecting its performance and warranty. Always disconnect the product from the electrical supply before cleaning.

Cleaning External Painted Surfaces featuring “Anti-bacterial Paint Finish”

The water bath should be cleaned at regular intervals wiping external surfaces with a cloth or sponge soaked in warm soapy water with a mild detergent. All surfaces should be cleaned using a soft cloth or sponge.



Do not under any circumstances use strong solvents or solutions containing Chlorinated Hydrocarbons, Esters, Ketones or abrasive cleaners or polish on the paint finish otherwise it damages the built in anti-bacterial properties.

All painted surfaces on Clifton range products features an “Anti-bacterial paint finish” identified with this authenticating logo on the unit. This “Anti-bacterial paint finish” inhibits the growth of bacteria. It has been tested by independent specialist test houses such as the Law Laboratories (in the UK) using internationally recognized test methods and proven to be effective versus a wide range of bacteria species including Escherichia coli and Staphylococcus aureus (MRSA).



We recognise hygienic coatings are part of a controlled approach to a cleaner working environment. Within its formulation an active ingredient with proven anti-bacterial properties is bound into the paint finish. The efficacy of the paint finish applied to the Clifton range is maintained over its lifetime, as the anti-bacterial agent is integral within the paint.

In a laboratory environment it makes this one less source of contamination, contributing to essential clean working practices. A benefit of such a paint finish can lead to a reduction in cleaning schedules because surfaces are more protected and improves protection between cleaning. Unlike detergents “Anti-bacterial paint finish” does not offer an instantaneous action, but is intended for long-term general protection against bacterial growth.

Moisture on the painted surface is necessary for the bacterium to absorb the agent and be affected by it. The coating is therefore less active in very dry conditions, but dependent upon relative humidity, moisture in the atmosphere maintains activity. Areas where moisture is trapped are also areas that normally are difficult to clean and where bacteria proliferate but these areas are most active for the anti-bacterial coating improving the defence against bacterial growth.

Cleaning the Stainless Steel Tank

The stainless steel crevice free tank with smooth corners should provide years of valuable service and is resistant to chloride containing solutions it is however important to avoid high concentrations of halogens - especially chloride. With such a high quality and resistant tank it may show symptoms of these halogens as rust, which are deposits from external sources in the water supply.

We recommend always empty the bath of liquid after use and wipe out the internal faces of the tank with a non-abrasive cloth and allow to dry. Any deposits can be removed with nitric acid (10%) on a cloth. **WEAR PROTECTIVE EQUIPMENT!**

It is also recommended to use an accessory lid to prevent contaminates landing in bath liquids.

Descaling the Stainless Steel Tank

Descal the stainless steel tank regularly to maintain it in as new condition ensuring the corrosion resistance and normal operating conditions are maintained throughout its working life. Descal by adding 1 litre of vinegar to water and gently heating to 50° C for an hour, empty and brush the lime away.

Rinse thoroughly afterwards.

Decontamination of Equipment

Clifton laboratory equipment can be decontaminated after spillage or contact with potentially HIV and Hepatitis infected blood samples during analysis using following recommended rapid disinfectants.

Virucidal Disinfectant

We recommend Virkon tablets for the safe and rapid disinfection of equipment in a wide variety of situations available from your distributor or contact Day-Impex Ltd. for more details. Telephone: 44+(0)1787 223232 or <http://www.day-impex.co.uk>

The ultimate high level surface disinfectant, dissolve VIRKON in water, providing a safe working solution with a faint lemon odor. It has proven efficacy against bacteria (including mycobacteria), viruses, spores and fungi in a variety of independent tests using different protocols. Presents no serious long term health risks to staff - obviating the need for costly ventilation equipment and health monitoring. Also provides high level disinfection of laboratory equipment and instruments where autoclaving is neither practical nor necessary. For more detailed information relating to how Virkon should be used with access to test reports www.relyon.dupont.com



Is Virkon solution corrosive? Virkon solution requires only 10 minutes contact time to be effective so long-term exposure is not necessary and therefore will not corrode most materials. Care should be taken with Stainless steel water bath tanks, these surfaces should not be affected however, it is important that generally you do not leave Virkon solution in contact with metal surfaces "FOR LONGER THAN IS NECESSARY".

Virkon is Registered in accordance with the requirements of the Medical Devices Directive, (93/42/EEC) as a Medical Device.

Disinfectant/Sterilant

We recommend PeraSafe a powder product for the safe and rapid chemical sterilant of equipment in a wide variety of situations available from your distributor or contact Day-Impex Ltd for more details. Telephone: 44+(0)1787 223232 or <http://www.day-impex.co.uk>

PeraSafe has a proven safety profile for end-users with none of the undesirable properties of skin sensitisation, toxic fumes or unpleasant odours that are associated with aldehyde solutions.

Leading UK and USA microbiologists have proven PeraSafe to be active against viruses, mycobacteria and fungi. It is microbiologically superior to glutaraldehyde, destroying sporing bacteria in one minute. It has also been independently proven that PeraSafe sterilises in just 10 minutes.

For more detailed information relating to how PeraSafe should be used with access to test reports www.relyon.dupont.com



3 Year Warranty

Our service engineers are fully trained in the assembly, calibration and servicing of all Clifton instrumentation. Products can be returned to our comprehensively equipped service centre where a fast and efficient turnaround is guaranteed:

Service Department, Nickel Electro Limited, Oldmixon Crescent, Weston-super-Mare, North Somerset BS24 9BL, UK. Tel +44 (0)1934 626691 Fax +44 (0)1934 630300.

Out of Warranty

Our Service Department has comprehensive stock of chargeable spare parts maintaining working life of equipment or units can be returned for quotation before repairs are undertaken.

End of Life



This symbol indicates that this product should not be disposed of with your waste. Instead, dispose waste electrical equipment by handing it over to a designated collection point for the recycling of waste electrical and electronic equipment. The separate collection and recycling of your waste equipment at the time of disposal will help to conserve natural resources and ensure that it is recycled in a manner that protects human health and the environment. For more information about where you can drop off your waste equipment for recycling, in UK please contact Service Department, rest Europe contact your Distributor.

Health & Safety, unless in receipt of a Decontamination Notice or Report the unit cannot be returned or accepted for disposal.

Clifton electrical and electronic equipment has been designed for recycling and takes into account the dismantling and recovery its components and materials. Clifton products are easily recycled with majority of the product constructed from stainless or mild steels, which can readily be re-used or recycled.

In excess of 78% of this product range can be easily re-cycled economically.

Portable Appliance Testing

When conducting testing, ensure it is conducted by a qualified person.



DO NOT PAT TEST THE BATH UNLESS IT CONTAINS WATER.

THIS EQUIPMENT MUST NOT BE FLASH TESTED!

Accessories for NE4 Series

GRP Gable Lids

- GL1-14 GRP Gable Lid to suit 14 Litre Baths
- GL1-22 GRP Gable Lid to suit 9, 22 and 28 Litre Baths



Stainless Steel Gable Lids

- SL4-8 Stainless Steel Gable Lid to suit 8 Litre Baths
- SL4-14 Stainless Steel Gable Lid to suit 14 Litre Baths
- SL4-22 Stainless Steel Gable Lid to suit 22 and 28 Litre Baths
- SL4-38 Stainless Steel Gable Lid to suit 38 Litre Baths



Stainless Steel Flat Lids

- LD4-8 Flat One Piece Stainless Steel Lid to suit 8 Litre Capacity Bath
- LD4-14 Flat One Piece Stainless Steel Lid to suit 14 Litre Capacity Bath
- LD4-22 Flat One Piece Stainless Steel Lid to suit 22 and 28 Litre Capacity Bath
- LD4-38 Flat One Piece Stainless Steel Lid to suit 38 Litre Capacity Bath



Stainless Steel Raised Shelves

- RS4-14 Stainless Steel Raised Shelf to suit 14 Litre Baths
- RS4-22 Stainless Steel Raised Shelf to suit 22 and 28 Litre Baths

Stainless Steel Test Tube Racks - Dimensions 270 x 70 x 138mm (L x W x H)

- 6870 Stainless Steel Test Tube Rack 26 Hole x 17mm Diameter
 - 6871 Stainless Steel Test Tube Rack 16 Holes x 26mm Diameter
 - 6872 Stainless Steel Test Tube Rack 36 Holes x 13mm Diameter
 - 6873 Stainless Steel Test Tube Rack 18 Holes x 19mm Diameter/suitable for 1.5ml microtubes
 - 6900 Stainless Steel Test Tube Rack 12 Holes x 32mm Diameter
- Note: 8 Litre = 1 Rack, 14 Litre = 2 Racks, 22 and 28 Litre = 5 Racks



Miscellaneous

- LB-2.5 2.5 Litres - Lab Bath 4590 - Heat transfer fluid - Temperature range -15° to +90°C
- LB-5.0 5 Litres - Lab Bath 4590 - Heat transfer fluid - Temperature range -15° to +90°C
- TC-1 Thermometer Clip Complete With Bent Stem Spirit Filled Thermometer
- BX0616 Draining Syphon
- NE4-MB Mounting Bracket allows Thermostirrers or Thermocirculators to be mounted on any type of separate tank.
- BP0368 Polypropylene Spheres



For more information on Accessories www.nickel-electro.co.uk

FITTING ACCESSORIES FOR NE4 SERIES

GRP Gable Lids

Position the lid over the bath and lower into place.

The lids are designed to fit snugly so that condensate runs into the bath.

Stainless Steel Gable Lids

Position the lid over the bath and lower into place.

These lids have no drip points, provide full working height across the bath when fitted and have a ventilation gap.

Stainless Steel Flat Lids

Position the lid over the bath and lower into place.

Stainless Steel Raised Shelves

The raised shelf provides a reduced liquid depth for shallow vessels in NE4 series water baths. With recommended minimum water level in NE4 range of 70mm with this in place it will provide a working depth of 5mm or 35mm.

Stainless Steel Test Tube Racks

Place the loaded test tube rack into the bath on top of either the stainless steel perforated shelf or the raised shelf.

Thermometer Clip

This can be positioned anywhere on the perimeter of the bath by clipping over the edge. The thermometer then lies flush with the top edge of the bath to prevent accidental damage.

Draining Syphon

Allows the easy and quick emptying of any water bath. Water temperature must be below 45°C before emptying can commence.

Mounting Bracket

This Mounting Bracket is designed to fit the NE4 series Clifton Thermostirrers for mounting on any number of vessels or tanks.

Maximum tank thickness for the Bracket = 30mm. Thumb wheel adjuster secures the Bracket and Thermostirrer to tank.

Polypropylene Spheres

Place on top of the water/oil to provide a floating lid reducing evaporation and insulating the bath reducing heat losses.

STIRRED BATHS

NE4-T series, thermostat control

Stirred Clifton water baths are designed for immersion of flasks/bottles/racks in a highly stable temperature environment throughout the water bath. Available in a wide range of sizes suiting a variety of applications.

This entry level thermostatically controlled analogue Thermostirrer is housed in a durable corrosion resistant stainless steel body. Immersed components are corrosion resistant. The Thermostirrer features a safety cut-out float switch, illuminated on/off switch, heater and mains indications. The Thermostirrer is supplied with a stainless steel mounting bridge to fit the selected tank. Each bath consists of a 304 spec stainless steel tank contained within a sturdy outer case with chemical resistant paint finish and is complete with a stainless steel shelf, designed for good temperature stability.



Features Include:

- Sensitivity: $\pm 0.2^{\circ}\text{C}$
- Uniformity: $\pm 0.05^{\circ}\text{C}$
- Temperature range: ambient $+5^{\circ}\text{C}$ - 99°C §
- Thermostatic control - *easy to use*
- Totally unobstructed, crevice free, stainless steel tank
- Powerful stirring within tank - *for stable temperature control*
- Stainless steel tank - *corrosion resistant and easy to clean*
- Sturdy construction - *powder coated for a chemical resistant exterior*
- Safety cut-out float switch - *low liquid level protection*
- Removable sturdy stainless steel shelf
- Lids optional extra - *recommended above 60°C*

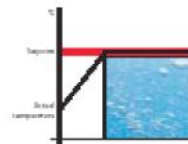
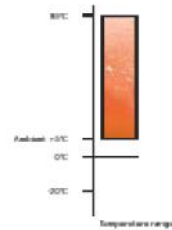

Cat No	NE4-8T	NE4-14T	NE4-22T	NE4-28T
Capacity Litres	8l	14l	22l	28l
Working Dims	129x332x150mm	219x298x150mm	395x298x150mm	395x298x200mm
Overall Dims	271x332x170mm	361x332x170mm	537x332x170mm	537x332x240mm
Heater Watts	1250W	1250W	1250W	1250W
Voltage	230V	230V	230V	230V



EC Declaration of Conformity

We herewith confirm the following product

NE4 Stirred Waterbath Range

Conforms with the requirements outlined by following European Directives.

Low Voltage Directive (2006/95/EC)
EMC Directive (89/336/EEC)

We confirm the declaration

NICKEL-ELECTRO LTD

Manufacturers of laboratory, medical and clinical equipment.

Oldmixon Crescent, Weston-super-Mare,
North Somerset, BS24 9BL, United Kingdom.

Tel: +44 (0)1934 626691

Fax: +44 (0)1934 630300

Email: clifton@nickel-electro.co.uk

www.nickel-electro.co.uk



Conforms with the requirements of following Standards

BS EN 61010:1

BS EN 61010:2.010

Safety requirements for electrical equipment for measurement, control and laboratory use.

BS EN 61326

Electrical equipment for measurement control and laboratory use - EMC requirements.

Nickel-Electro Ltd is also registered ISO9001 reference No. Q09820





NICKEL-ELECTRO Ltd.

Manufacturers of laboratory, medical and clinical equipment.

Oldmixon Crescent, Weston-super-Mare,
North Somerset, BS24 9BL, United Kingdom.

Tel: +44 (0)1934 626691
Fax: +44 (0)1934 630300

Email: clifton@nickel-electro.co.uk
www.nickel-electro.co.uk